

CAN-FD bus ESD protection diode

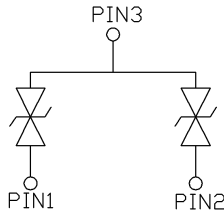

SOT-23



Features

- Epoxy meets UL-94 V-0 flammability rating and halogen free
- Moisture Sensitivity Level 1
- Dual Line CAN-FD Bus Protector for SOT-23 Package
- Max Peak Pulse Power 180W per Line ($t_p=8/20 \mu s$)
- IEC 61000-4-2, level 4 (ESD)
- IEC 61000-4-5 (surge), $I_{PP} = 5A$ at $t_p = 8/20 \mu s$
- Part no. with suffix "Q" means AEC-Q101 qualified

Applications

- Automotive Controlled Area Network

Mechanical Data

- **Case:** SOT-23
- **Terminals:** Tin plated leads, solderable per J-STD-002 and JESD22-B102

■ Maximum Ratings ($T_a=25^\circ C$ Unless otherwise specified)

PARAMETER	SYMBOL	UNIT	VALUE
Peak Pulse Power per Line ($t_p=8/20 \mu s$) (Note1)	P_{PP}	W	180
Peak Pulse Current per Line ($t_p=8/20 \mu s$) (Note1)	I_{PP}	A	5
Storage Temperature Range	T_{stg}	$^\circ C$	-55 ~ +150
Junction Temperature	T_J	$^\circ C$	-55 ~ +150
Human Body Model (HBM) (Note2)	V_{ESD}	kV	30
IEC 61000-4-2 (contact discharge) (Note2)		kV	30

Note1: Non-repetitive current pulse 8/20 μs exponential decay waveform according to IEC 61000-4-5.

Note2: Measured from pin 1 to 3 or 2 to 3.

■ Electrical Characteristics ($T_a=25^\circ C$ unless otherwise noted)

ITEM	SYMBOL	UNIT	CONDITIONS	MIN.	TYP.	MAX.
Reverse Working Voltage	V_{RWM}	V		-	-	24
Reverse Breakdown Voltage	V_{BR}	V	$I_r=1mA$	25.5		35.5
Reverse Leakage Current	I_R	nA	$V_{RWM}=24V$	-	1	50
Clamping Voltage(pin 1 to 3 or 2 to 3) ¹⁾	V_C	V	$I_{PP}=1A$ (8/20 μs Pulse)	-	22	32
Clamping Voltage(pin 1 to 3 or 2 to 3) ¹⁾	V_C	V	$I_{PP}=5A$ (8/20 μs Pulse)	-	27	36
Dynamic resistance 2)	R_{DYN}	Ω	TLP, $t_p=100ns$, I/O to Ground		0.46	
Junction Capacitance(pin 1 to 3 or 2 to 3)	C_j	pF	$V_R=0V$, $f=1MHZ$	-	6	10

Notes:

(1). Non-repetitive current pulse, according to IEC61000-4-5.

(2). TLP parameter: $Z_0 = 50\Omega$, $t_p = 100ns$, $t_r = 2ns$, averaging window from 60ns to 80ns. R_{DYN} is calculated from 4A to 16A.



■ Ordering Information (Example)

PREFERRED P/N	PACKING CODE	UNIT WEIGHT(g)	MINIMUM PACKAGE(pcs)	INNER BOX QUANTITY(pcs)	OUTER CARTON QUANTITY(pcs)	DELIVERY MODE
ESD2CANFD24T2Q	F2	Approximate 0.01	3000	30000	120000	7" reel

■ Characteristics (Typical)

Fig.1: 8/20 μ s Pulse Waveform

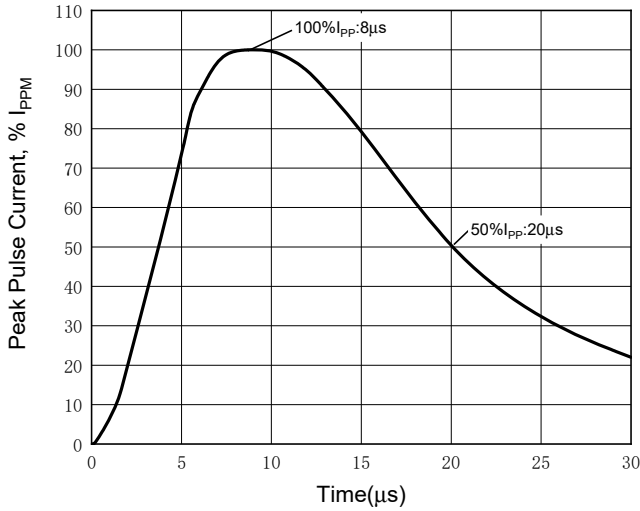

Fig.2 :Peak Pulse Current vs Clamping Voltage

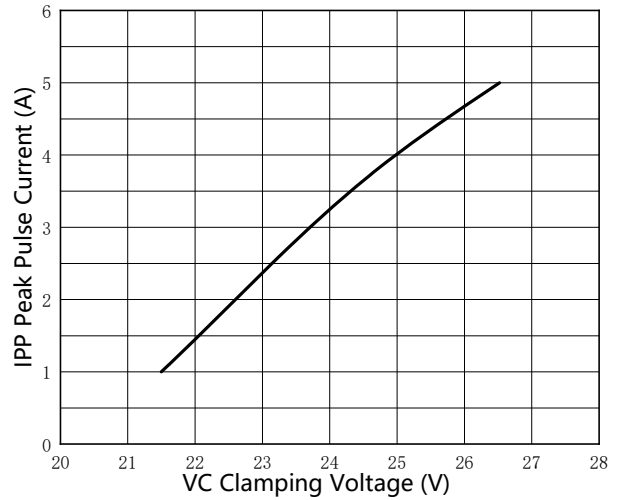

Fig.3: Power Derating Curve

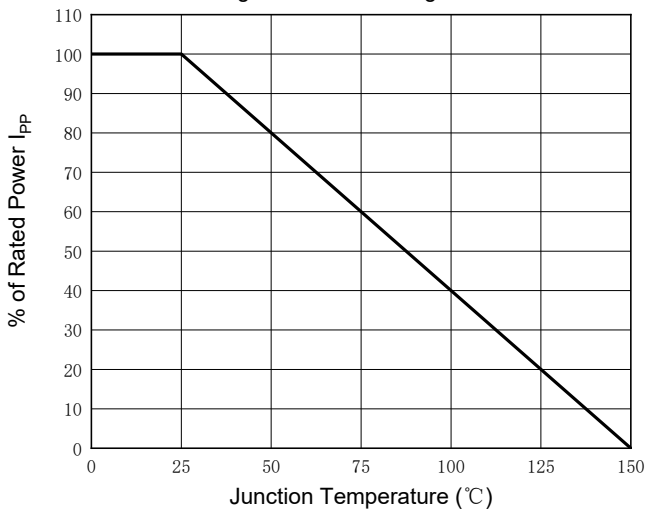

Fig.4: Capacitance vs. Bias

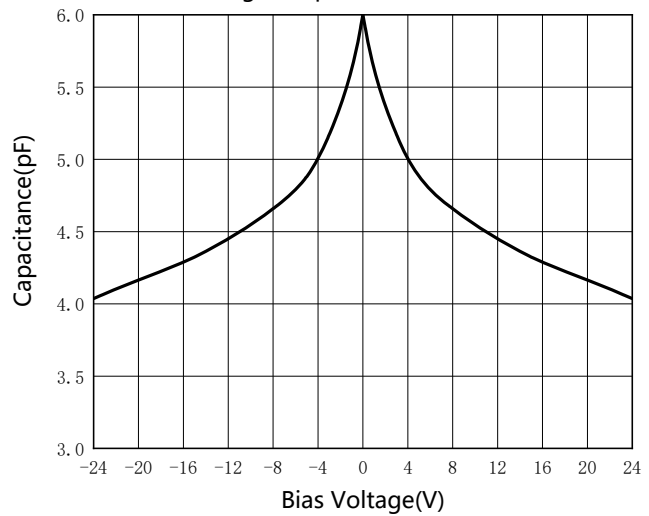
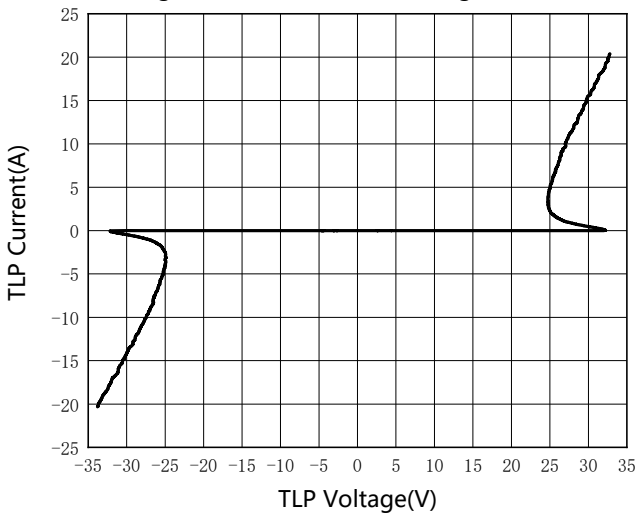
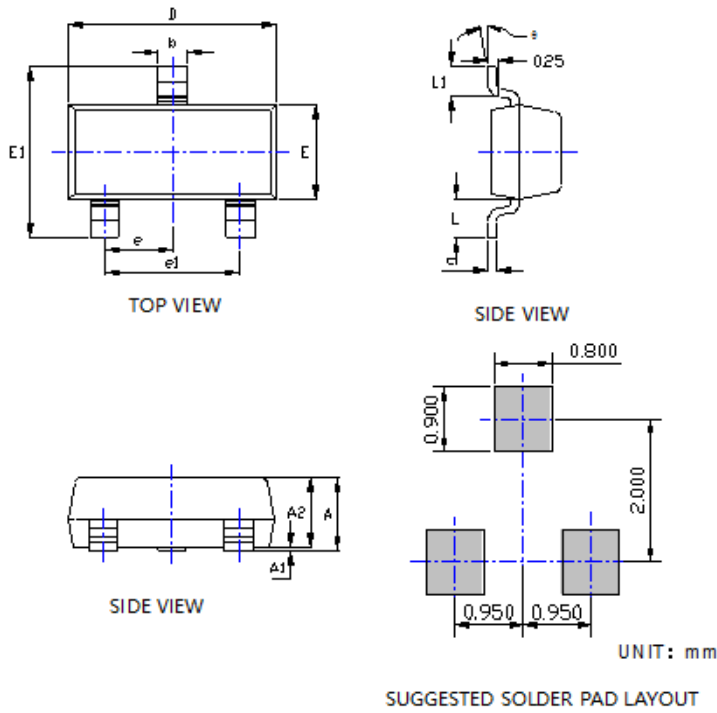

Fig.5:Transmission Line Pulsing(TLP) Plot



■ Outline Dimensions



SYMBOL	DIMENSIONS			
	INCHES		Millimeter	
	MIN.	MAX.	MIN.	MAX.
A	0.035	0.045	0.900	1.150
A1	0.000	0.004	0.000	0.100
A2	0.035	0.041	0.900	1.050
b	0.012	0.020	0.300	0.500
c	0.004	0.008	0.100	0.200
D	0.110	0.118	2.800	3.000
E	0.047	0.055	1.200	1.400
E1	0.089	0.100	2.250	2.550
e	0.037TYP		0.950TYP	
e1	0.071	0.079	1.800	2.000
L	0.022REF		0.550REF	
L1	0.012	0.020	0.300	0.500
θ	0°	8°	0°	8°

NOTE:
 1. PACKAGE BODY SIZES EXCLUDE MOLD FLASH AND GATE BURRS.
 2. TOLERANCE 0.1mm UNLESS OTHERWISE SPECIFIED.
 3. THE PAD LAYOUT IS FOR REFERENCE PURPOSES ONLY.

■ Marking Information

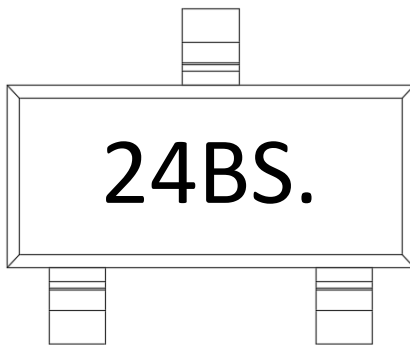

- Note:
1. All marking is at middle of the product body
 2. All marking is in laser marking
 3. Body color: Black



Disclaimer

The information presented in this document is for reference only. Yangzhou Yangjie Electronic Technology Co., Ltd. reserves the right to make changes without notice for the specification of the products displayed herein to improve reliability, function or design or otherwise.

The product listed herein is designed to be used with automotive electronics, are not designed for use in medical, life-saving, lifesustaining, or military, Yangjie or anyone on its behalf, assumes no responsibility or liability for any damages resulting from such improper use of sale.

This publication supersedes & replaces all information previously supplied. For additional information, please visit our website [http:// www.21yangjie.com](http://www.21yangjie.com) , or consult your nearest Yangjie's sales office for further assistance.