

NPN Transistor

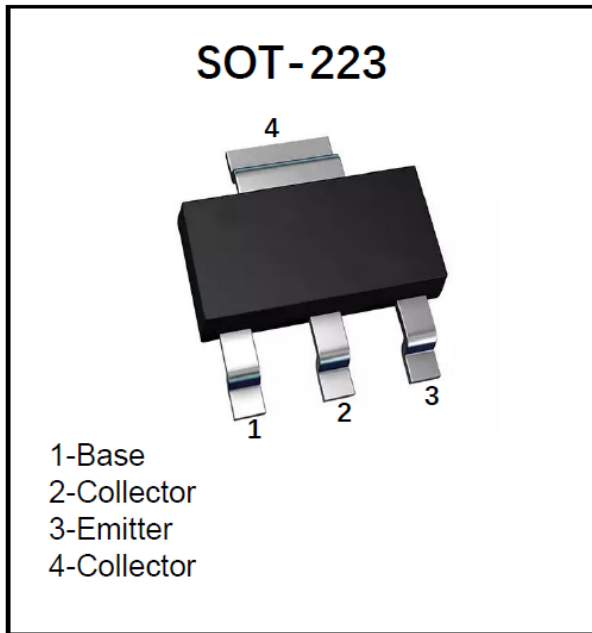

Features

- Epoxy meets UL-94 V-0 flammability rating
- Halogen free available upon request by adding suffix "HF"
- Moisture Sensitivity Level 1

Mechanical Data

- **Package:** SOT-223
- **Terminals:** Tin plated leads, solderable per J-STD-002 and JESD22-B102
- **Marking:** ZT3904

■Equivalent circuit

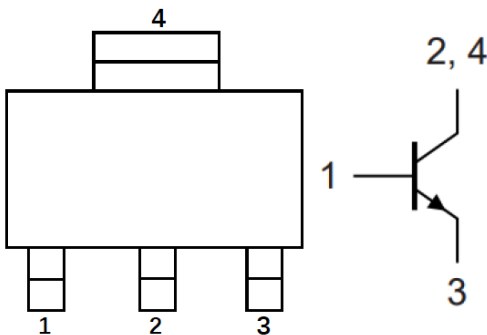

■Maximum Ratings (Ta=25°C unless otherwise noted)

Item	Symbol	Unit	Conditions	Value
Minimum Collector-Emitter Voltage	V_{CEO}	V	$I_C=1mA, I_B=0$	40
Minimum Collector-Base Voltage	V_{CBO}	V	$I_C=10\mu A, I_E=0$	60
Minimum Emitter-Base Voltage	V_{EBO}	V	$I_E=10\mu A, I_C=0$	6
Collector Current	I_C	A		0.2
Power Dissipation	P_D	W		1
Thermal Resistance From Junction To Ambient	$R_{\theta JA}$	°C/W		125
Operation Junction Temperature	T_J	°C		-55 to +150
Storage Temperature	T_{stg}	°C		-55 to +150



PZT3904

■Electrical Characteristics (Ta=25°C unless otherwise noted)

Item	Symbol	Unit	Conditions	Min	Typ	Max
Collector-base breakdown voltage	V_{CB0}	V	$I_C=10\mu A, I_E=0$	60	-	-
Collector-emitter breakdown voltage	V_{CE0}	V	$I_C=1mA, I_B=0$	40	-	-
Emitter-base breakdown voltage	V_{EB0}	V	$I_E=10\mu A, I_C=0$	6	-	-
Collector-emitter cut-off current	I_{CEX}	nA	$V_{CE}=30V, V_{EB}=3V$	-	-	50
Collector-base cut-off current	I_{CBO}	nA	$V_{CB}=30V, I_E=0$	-	-	50
Emitter-base cut-off current	I_{EBO}	nA	$V_{EB}=5V, I_C=0$	-	-	50
DC current gain	h_{FE}		$V_{CE}=1V, I_C=0.1mA$	40	-	-
	h_{FE}		$V_{CE}=1V, I_C=1mA$	70	-	-
	h_{FE}		$V_{CE}=1V, I_C=10mA$	100	-	300
	h_{FE}		$V_{CE}=1V, I_C=50mA$	60	-	-
Collector-emitter saturation voltage	$V_{CE(sat)}$	V	$I_C=10mA, I_B=1mA$	-	-	0.2
			$I_C=50mA, I_B=5mA$	-	-	0.3
Base-emitter saturation voltage	$V_{BE(sat)}$	V	$I_C=10mA, I_B=1mA$	0.65	-	0.85
			$I_C=50mA, I_B=5mA$	-	-	0.95
Transition frequency	f_T	MHz	$V_{CE}=20V, I_C=10mA, f=100MHz$	300	-	-
Output Capacitance	C_{ob}	pF	$V_{CB}=5V, I_E=0, f=1MHz$	-	-	4
Delay time	t_d	ns	$V_{CC}=3.0Vdc, V_{BE}=0.5Vdc, I_C=10mAdc, I_{B1}=1.0mAdc$	-	-	35
Rise time	t_r	ns		-	-	35
Storage time	t_s	ns	$V_{CC}=3.0Vdc, I_C=10mAdc, I_{B1}=-I_{B2}=1.0mAdc$	-	-	200
Fall time	t_f	ns		-	-	50

■Ordering Information (Example)

PREFERRED P/N	PACKING CODE	UNIT WEIGHT(g)	MINIMUM PACKAGE(pcs)	INNER BOX QUANTITY(pcs)	OUTER CARTON QUANTITY(pcs)	DELIVERY MODE
PZT3904	F2	Approximate 0.11	2500	5000	25000	13" reel



■ Characteristics (Typical)

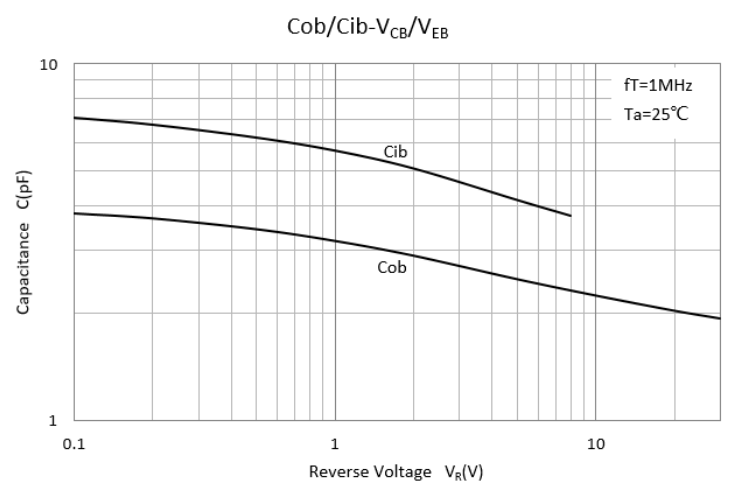
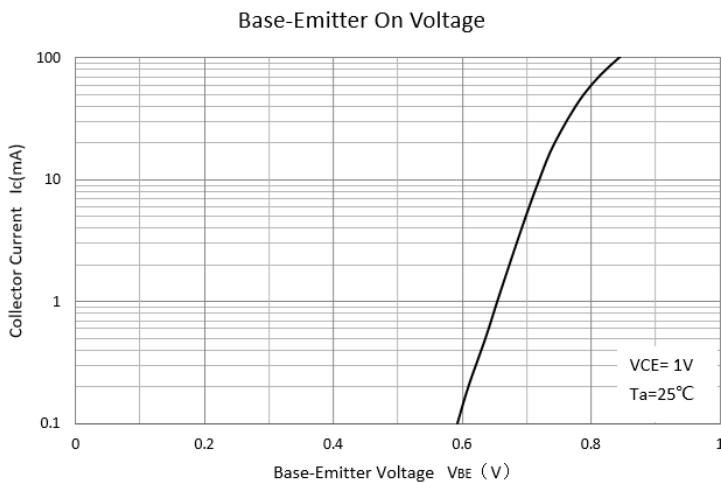
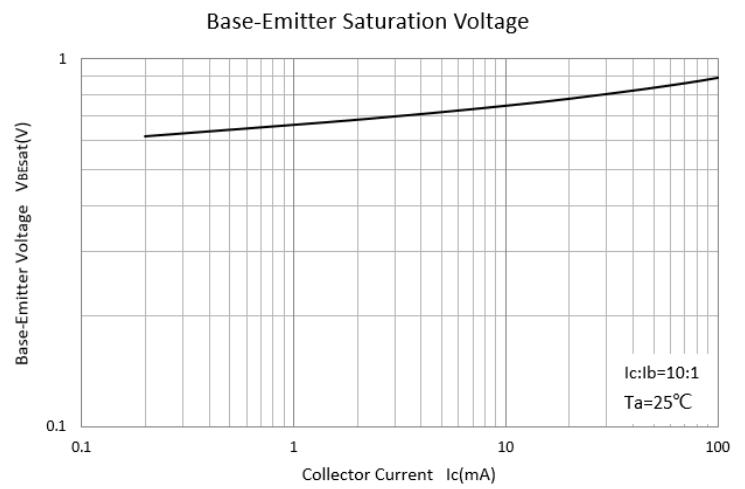
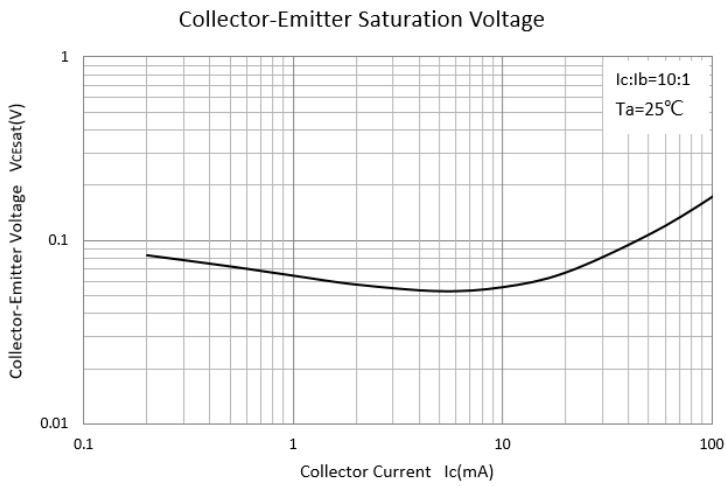
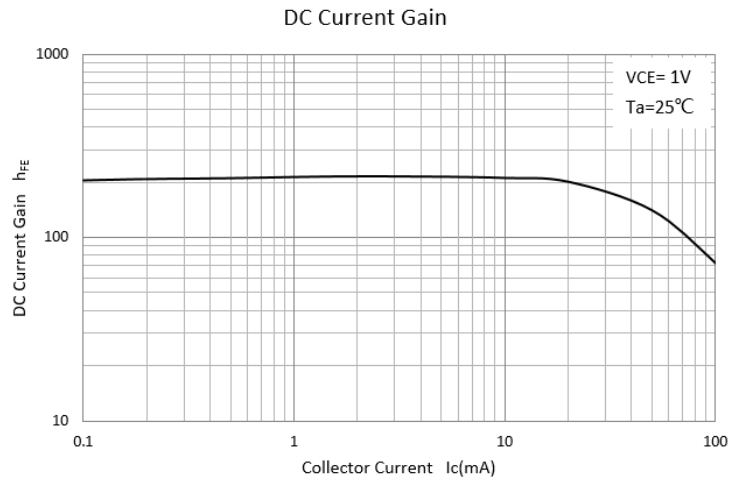
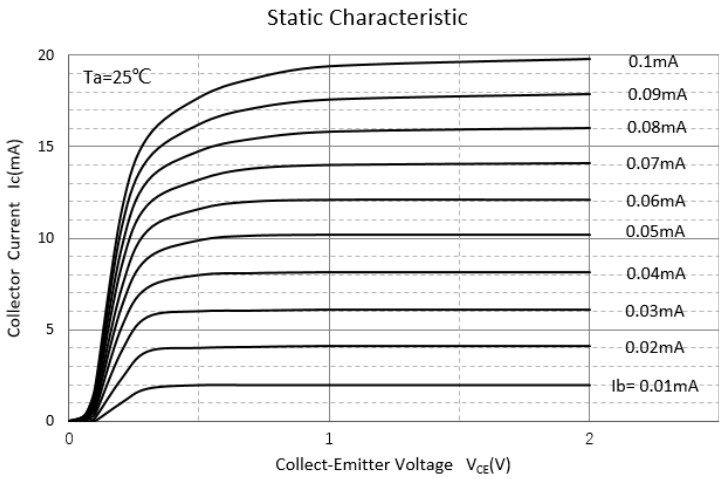

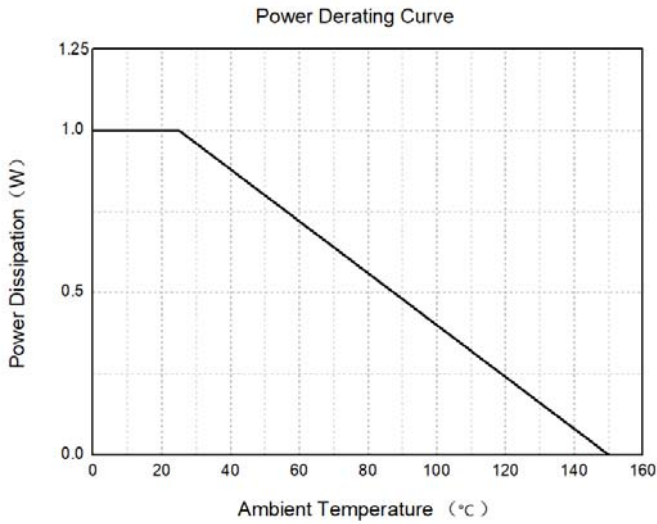

■SOT-223 Package Outline Dimensions

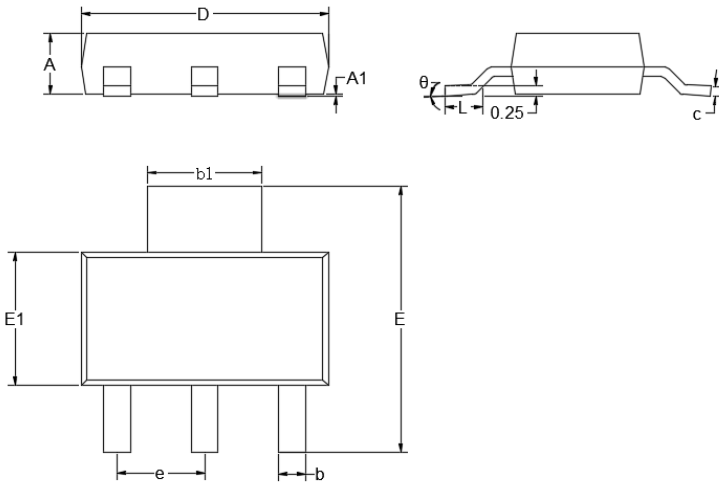

DIMENSIONS				
DIM	INCHES		MM	
	MIN	MAX	MIN	MAX
A	0.0591	0.0670	1.5000	1.7000
A1	0.0008	0.0039	0.0200	0.1000
b	0.0259	0.0330	0.6600	0.8400
b1	0.1140	0.1220	2.9000	3.1000
c	0.0090	0.0138	0.2300	0.3500
D	0.2480	0.2640	6.3000	6.7000
E	0.2637	0.2874	6.7000	7.3000
E1	0.1290	0.1460	3.3000	3.7000
e	0.0866	0.0945	2.2000	2.4000
L	0.0295	0.0492	0.7500	1.2500
θ	0°	10°	0°	10°

■SOT-223 Suggested Pad Layout

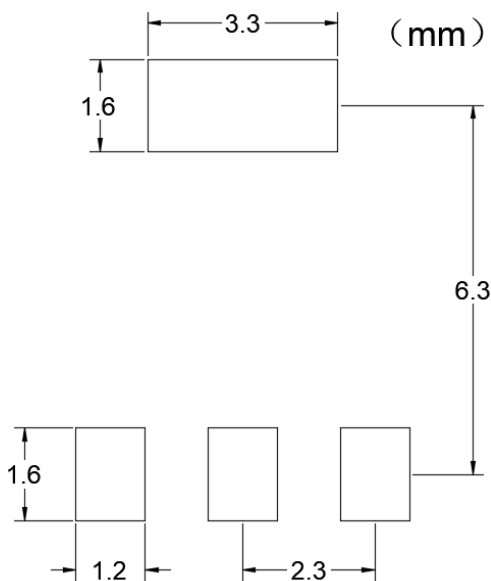



Disclaimer

The information presented in this document is for reference only. Yangzhou Yangjie Electronic Technology Co., Ltd. reserves the right to make changes without notice for the specification of the products displayed herein to improve reliability, function or design or otherwise.

The product listed herein is designed to be used with ordinary electronic equipment or devices, and not designed to be used with equipment or devices which require high level of reliability and the malfunction of which would directly endanger human life (such as medical instruments, transportation equipment, aerospace machinery, nuclear-reactor controllers, fuel controllers and other safety devices), Yangjie or anyone on its behalf, assumes no responsibility or liability for any damages resulting from such improper use of sale.

This publication supersedes & replaces all information previously supplied. For additional information, please visit our website [http:// www.21yangjie.com](http://www.21yangjie.com) , or consult your nearest Yangjie's sales office for further assistance.