

Dual NPN+PNP Small Signal Transistor

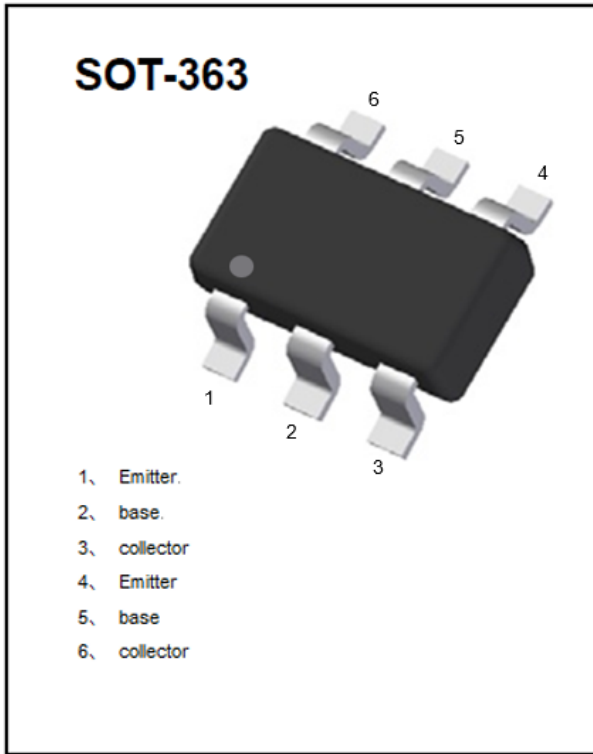

Features

- Epoxy meets UL-94 V-0 flammability rating
- Surface mount package ideally Suited for Automatic Insertion
- NPN/PNP

Mechanical Data

- **Package:** SOT-363
- **Terminals:** Tin plated leads, solderable per J-STD-002 and JESD22-B102
- **Marking:** 7P

Equivalent circuit

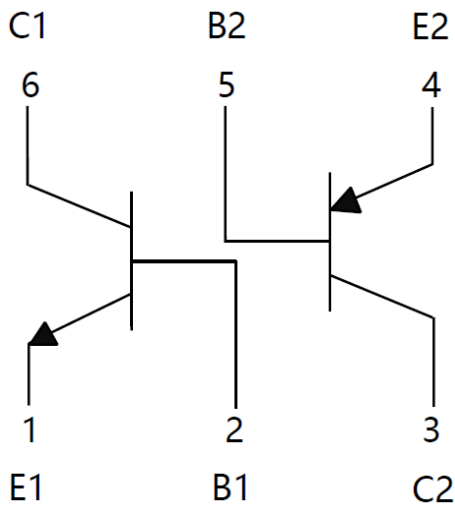

Ordering Information (Example)

PREFERRED P/N	PACKING CODE	UNIT WEIGHT(g)	MINIMUM PACKAGE(pcs)	INNER BOX QUANTITY(pcs)	OUTER CARTON QUANTITY(pcs)	DELIVERY MODE
BC847PN	F2	Approximate 0.009g	3000	30000	120000	7" reel



BC847PN

■TR1 NPN Pin1、 2、 6 Maximum Ratings (Ta=25°C Unless otherwise specified)

Item	Symbol	Unit	Conditions	Value
Collector-Base Voltage	V_{CBO}	V	$I_C=10\mu A, I_E=0$	50
Collector-Emitter Voltage	V_{CEO}	V	$I_C=10mA, I_B=0$	45
Emitter-Base Voltage	V_{EBO}	V	$I_E=1\mu A, I_C=0$	6
Collector Current	I_C	mA		100
Collector Power Dissipation	P_C	mW		200
Junction Temperature	T_j	°C		-55 to +150
Storage Temperature	T_{stg}	°C		-55 to +150

■TR1 NPN Pin1、 2、 6 Electrical Characteristics (Ta=25°C unless otherwise specified)

Item	Symbol	Unit	Conditions	Min	TYP	Max
Collector-base breakdown voltage	V_{CBO}	V	$I_C=10\mu A, I_E=0$	50		
Collector-emitter breakdown voltage	V_{CEO}	V	$I_C=10mA, I_B=0$	45		
Emitter-base breakdown voltage	V_{EBO}	V	$I_E=1\mu A, I_C=0$	6		
Collector-Base cut-off current	I_{CBO}	nA	$V_{CB}=30V, I_E=0$			15
Emitter-Base Cut-off current	I_{EBO}	nA	$V_{EB}=5V, I_C=0$			100
DC current gain	h_{FE}		$V_{CE}=5V, I_C=2mA$	200		450
Collector-emitter saturation voltage	$V_{CE(sat)}$	V	$I_C=10mA, I_B=0.5mA$			0.25
			$I_C=100mA, I_B=5mA$			0.6
Baser-emitter saturation voltage	$V_{BE(sat)}$	V	$I_C=10mA, I_B=0.5mA$			1.05
			$I_C=100mA, I_B=5mA$			1.1
Base-emitter Voltage	V_{BE}	V	$V_{CE}=5V, I_C=2mA$			0.7
			$V_{CE}=5V, I_C=10mA$			0.72
Transition frequency	f_T	MHz	$V_{CE}=5V, I_C=10mA, f=100MHz$	100		
Noise figure	NF	dB	$V_{CE}=5V, I_C=0.2mA, f=1kHz, R_g=2K\Omega, \Delta f=200Hz$			10



BC847PN

■TR2 PNP Pin3、4、5 Maximum Ratings (Ta=25°C Unless otherwise specified)

Item	Symbol	Unit	Conditions	Value
Collector-Base Voltage	V_{CBO}	V	$I_C=-10\mu A, I_E=0$	-50
Collector-Emitter Voltage	V_{CEO}	V	$I_C=-10mA, I_B=0$	-45
Emitter-Base Voltage	V_{EBO}	V	$I_E=-1\mu A, I_C=0$	-5
Collector Current	I_C	mA		-100
Collector Power Dissipation	P_C	mW		200
Junction Temperature	T_j	°C		-55 to +150
Storage Temperature	T_{stg}	°C		-55 to +150

■TR2 PNP Pin3、4、5 Electrical Characteristics (Ta=25°C unless otherwise specified)

Item	Symbol	Unit	Conditions	Min	TYP	Max
Collector-base breakdown voltage	V_{CBO}	V	$I_C=-10\mu A, I_E=0$	-50		
Collector-emitter breakdown voltage	V_{CEO}	V	$I_C=-10mA, I_B=0$	-45		
Emitter-base breakdown voltage	V_{EBO}	V	$I_E=-1\mu A, I_C=0$	-6		
Collector-Base cut-off current	I_{CBO}	nA	$V_{CB}=-30V, I_E=0$			-15
Emitter-Base Cut-off current	I_{EBO}	nA	$V_{EB}=-5V, I_C=0$			-100
DC current gain	h_{FE}		$V_{CE}=-5V, I_C=-2mA$	220		475
Collector-emitter saturation voltage	$V_{CE(sat)}$	V	$I_C=-10mA, I_B=-0.5mA$			-0.3
			$I_C=-100mA, I_B=-5mA$			-0.65
Baser-emitter saturation voltage	$V_{BE(sat)}$	V	$I_C=-10mA, I_B=-0.5mA$			-1
			$I_C=-100mA, I_B=-5mA$			-1
Base-emitter Voltage	V_{BE}	V	$V_{CE}=-5V, I_C=-2mA$			-0.75
			$V_{CE}=-5V, I_C=-10mA$			-0.82
Transition frequency	f_T	MHz	$V_{CE}=-5V, I_C=-10mA, f=100MHz$	100		
Noise figure	NF	dB	$V_{CE}=-5V, I_C=-0.2mA, f=1kHz, R_g=2K\Omega, \Delta f=200Hz$			10



BC847PN

■ TR1 NPN Pin1、2、6 Characteristics (Typical)

Static Characteristic

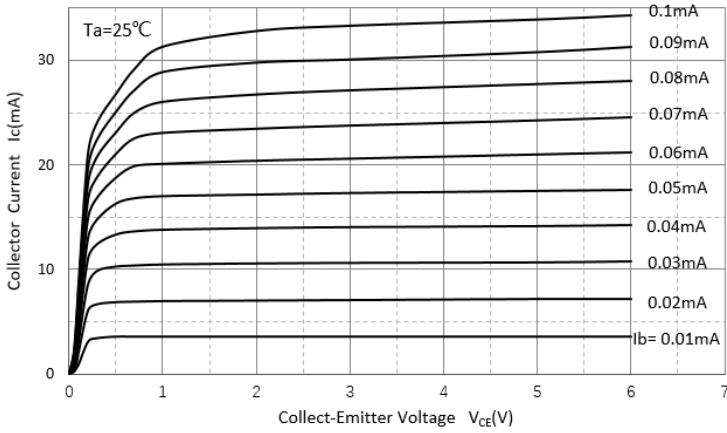

DC Current Gain

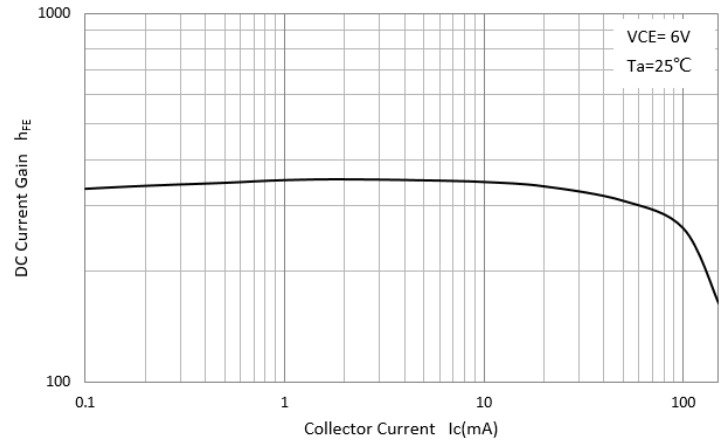

Collector-Emitter Saturation Voltage

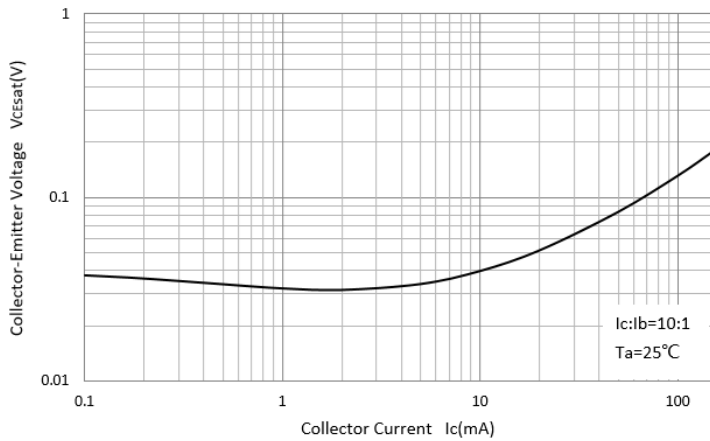

Base-Emitter Saturation Voltage

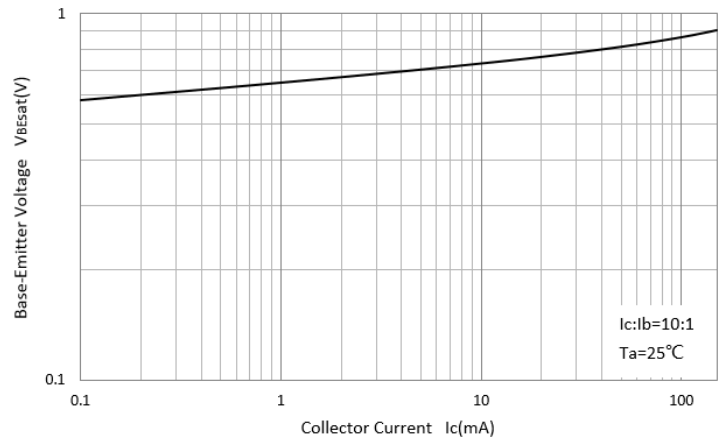

Base-Emitter On Voltage

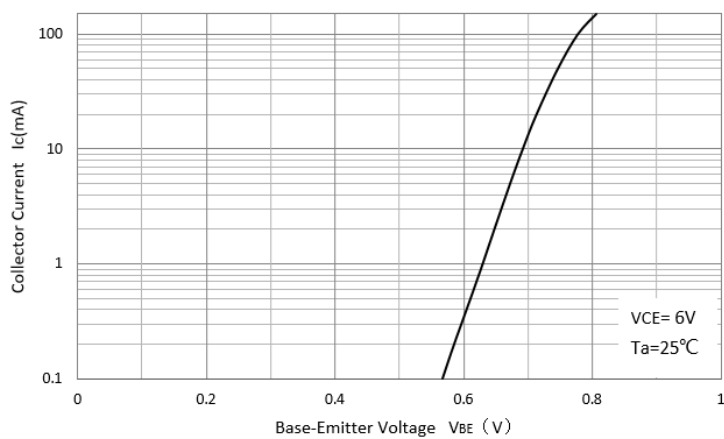

$C_{ob}/C_{ib}-V_{CB}/V_{EB}$

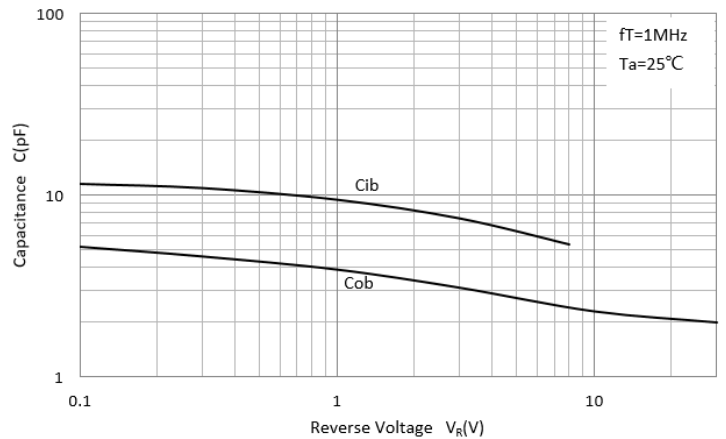



BC847PN

■ TR2 PNP Pin3、4、5 Characteristics (Typical)

Static Characteristic

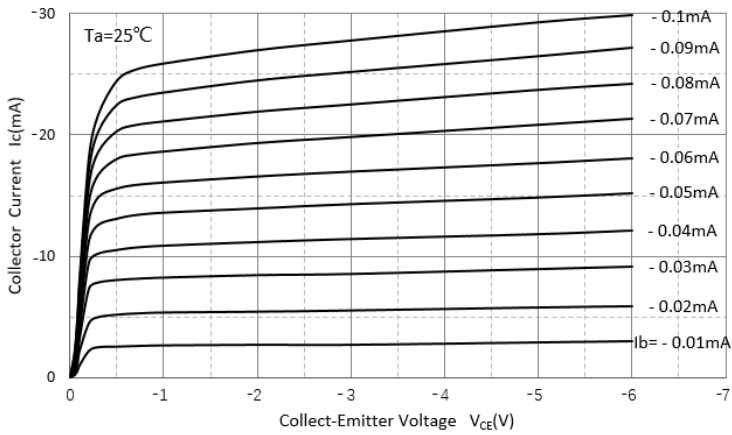

DC Current Gain

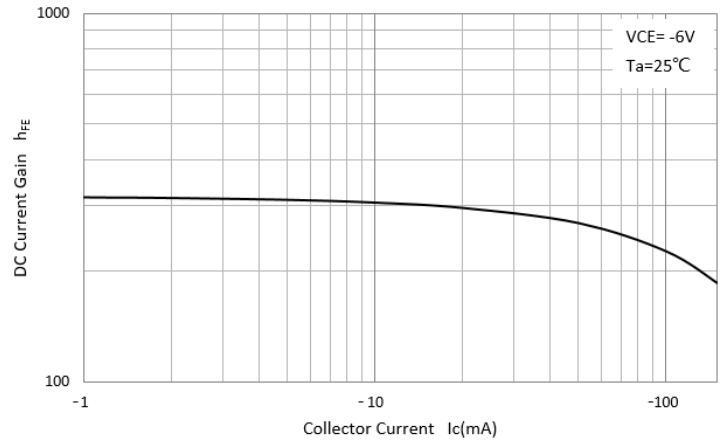

Collector-Emmitter Saturation Voltage

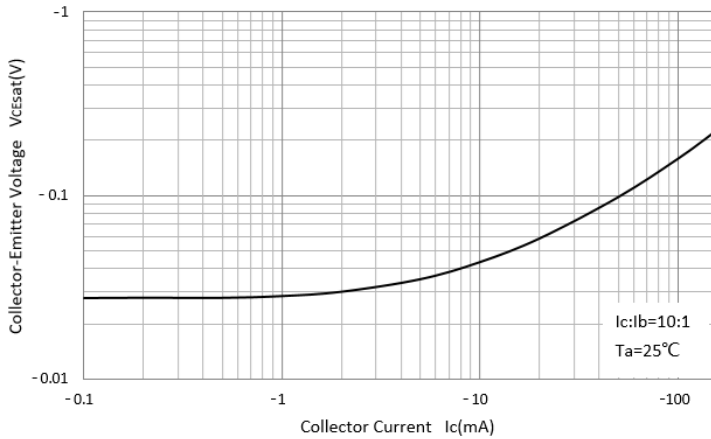

Base-Emmitter Saturation Voltage

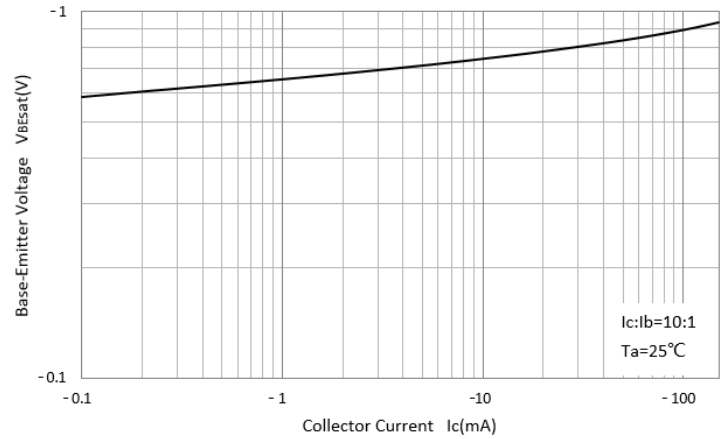

Base-Emmitter On Voltage

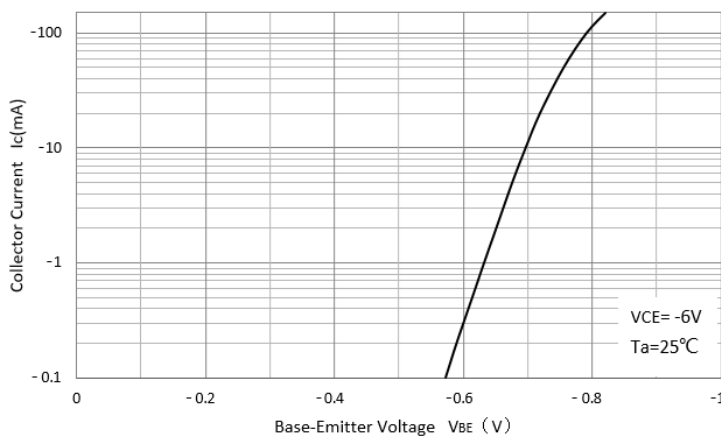

$C_{ob}/C_{ib}-V_{CB}/V_{EB}$

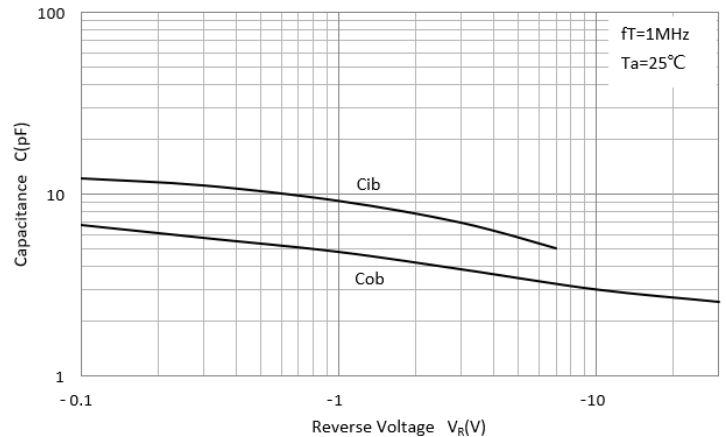



BC847PN

■SOT-363 Package Outline Dimensions

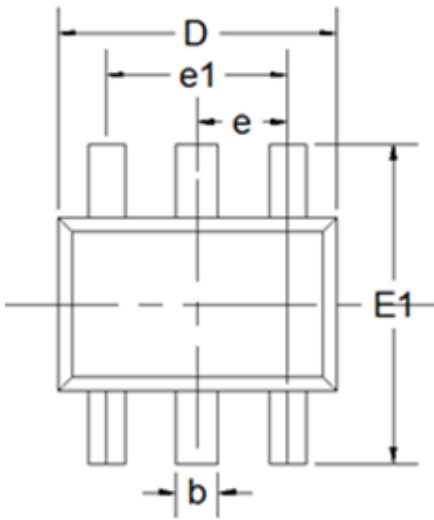

DIM	DIMENSIONS			
	INCHES		MM	
	MIN	MAX	MIN	MAX
A	0.035	0.043	0.9	1.1
A1	0	0.004	0	0.1
A2	0.035	0.039	0.9	1
b	0.006	0.014	0.15	0.35
c	0.002	0.01	0.05	0.25
D	0.071	0.087	1.8	2.2
E	0.045	0.053	1.15	1.35
E1	0.085	0.096	2.15	2.45
e	0.026Typ		0.65Typ	
e1	0.047	0.055	1.2	1.4
L	0.021Typ		0.525Typ	
L1	0.01	0.018	0.26	0.46
φ	0°	8°	0°	8°

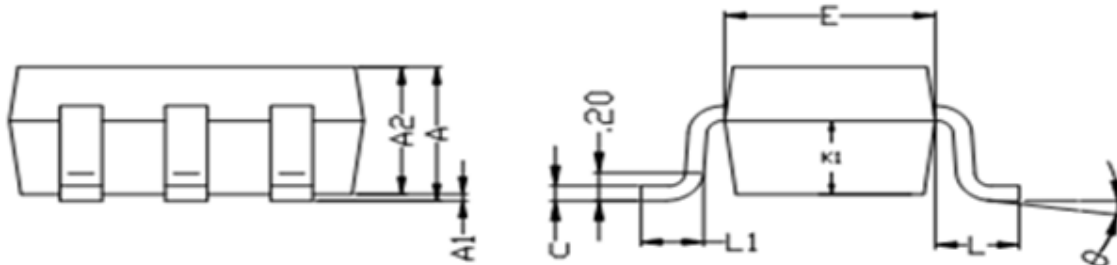

■SOT-363 Soldering Footprint

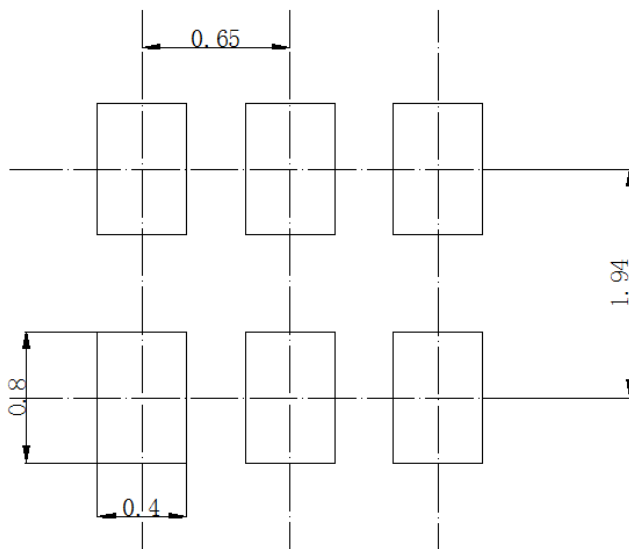

Unit: mm



BC847PN

Disclaimer

The information presented in this document is for reference only. Yangzhou Yangjie Electronic Technology Co., Ltd. reserves the right to make changes without notice for the specification of the products displayed herein to improve reliability, function or design or otherwise.

The product listed herein is designed to be used with ordinary electronic equipment or devices, and not designed to be used with equipment or devices which require high level of reliability and the malfunction of which would directly endanger human life (such as medical instruments, transportation equipment, aerospace machinery, nuclear-reactor controllers, fuel controllers and other safety devices), Yangjie or anyone on its behalf, assumes no responsibility or liability for any damages resulting from such improper use of sale.

This publication supersedes & replaces all information previously supplied. For additional information, please visit our website [http:// www.21yangjie.com](http://www.21yangjie.com) , or consult your nearest Yangjie's sales office for further assistance.